

# DESSINS TECHNIQUES

MISE EN PLACE – MONTANTS ALU AVEC EMBASES  
MONTAGE DU VERRE À EXTÉRIEUR

## ANGLE SORTANT

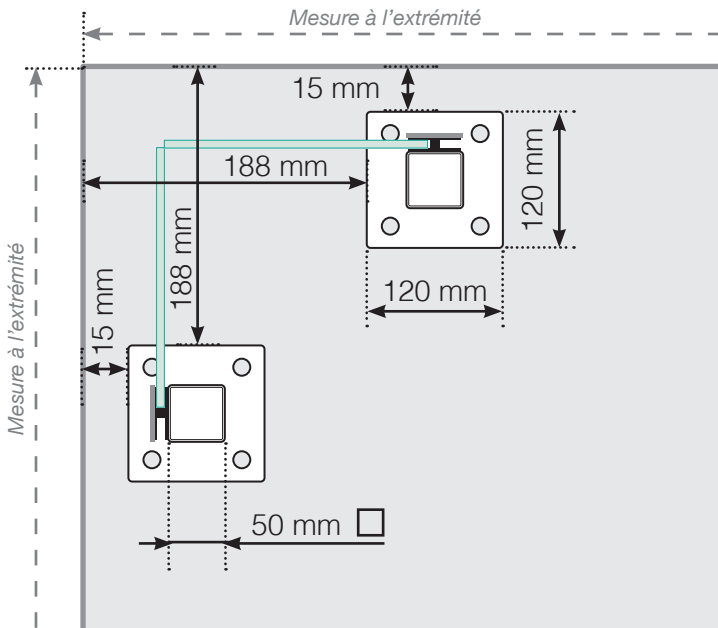

## ANGLE SORTANT $\neq 90^\circ$

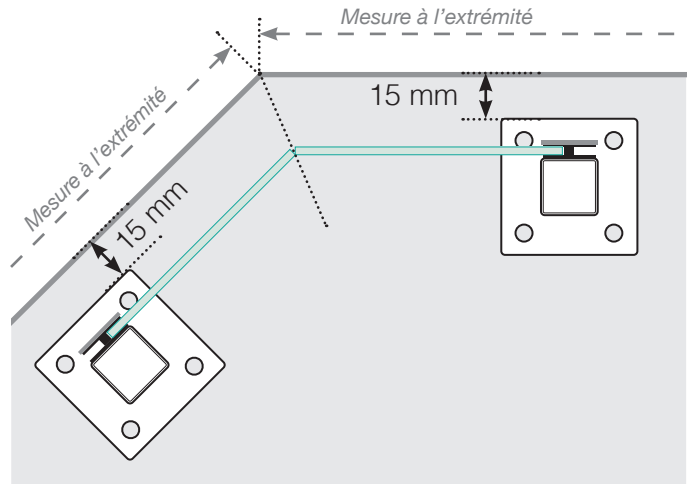

## ANGLE RENTRANT $\neq 90^\circ$

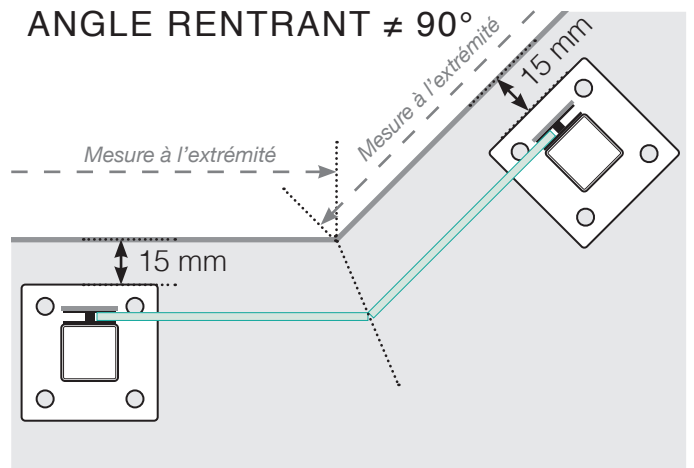

## ANGLE RENTRANT

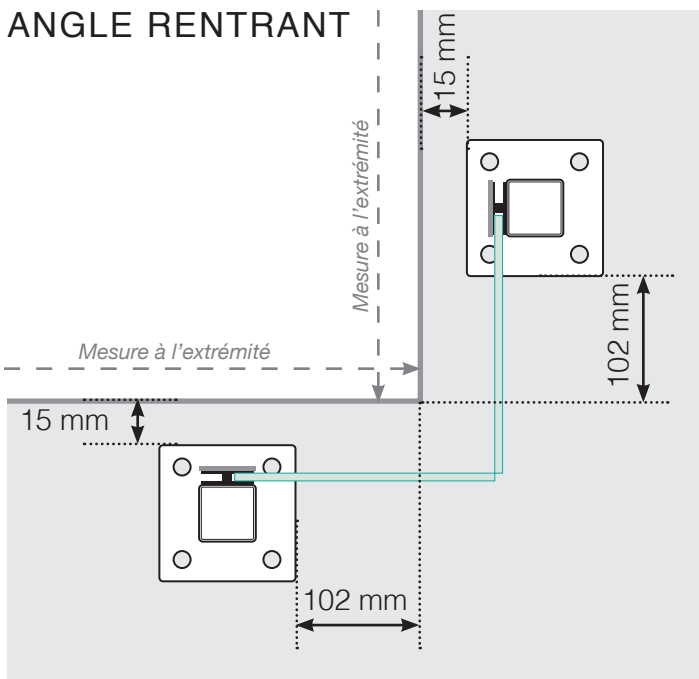

## POTEAU DE FIN

Libre

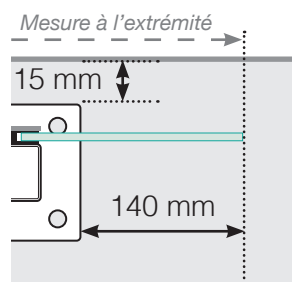

Libre Fixé au mur

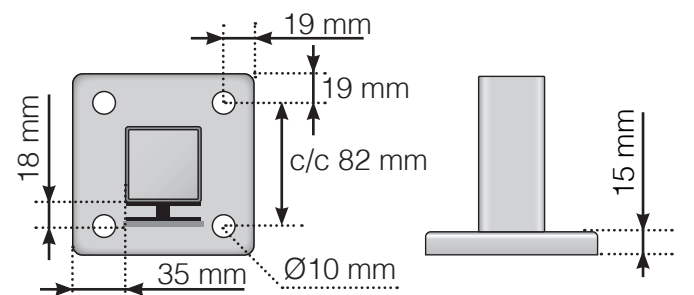
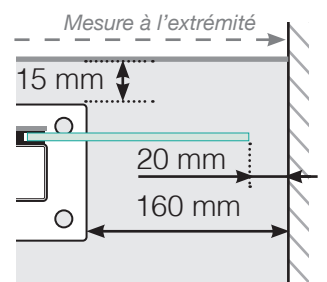

Veuillez noter que les dessins ne sont pas à l'échelle.

© Räckesbutiken Sweden AB - www.maisondugarde-corps.fr

23/09/20 v.1.0



MAISONDUGARDE-CORPS.FR