

# DESSINS TECHNIQUES

MISE EN PLACE – MONTANTS ALU AVEC EMBASES  
MONTAGE DU VERRE À EXTÉRIEUR

## ANGLE SORTANT

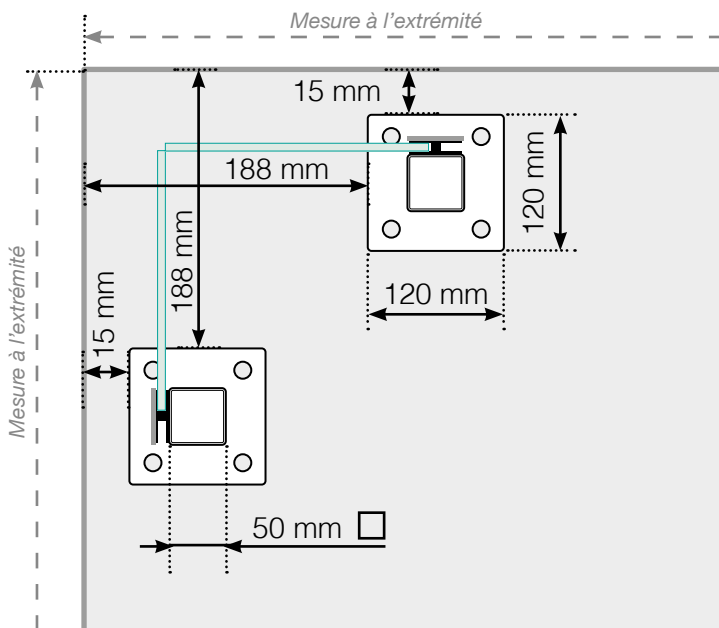

## ANGLE SORTANT $\neq 90^\circ$

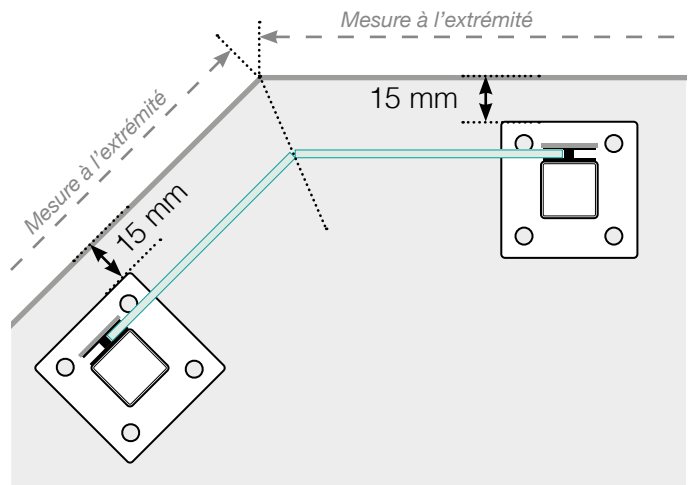

## ANGLE RENTRANT $\neq 90^\circ$

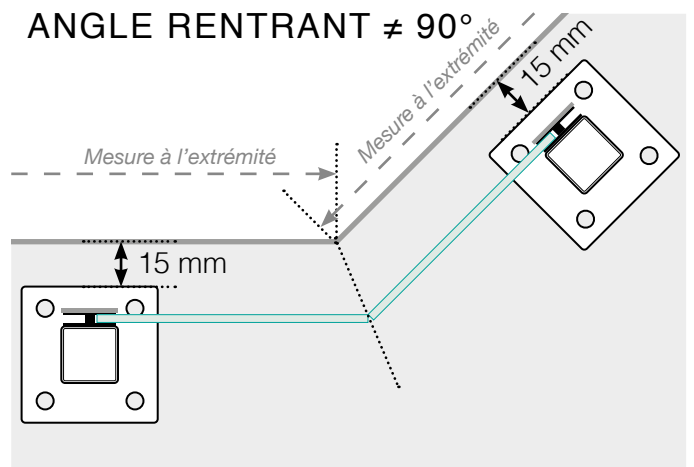

## ANGLE RENTRANT

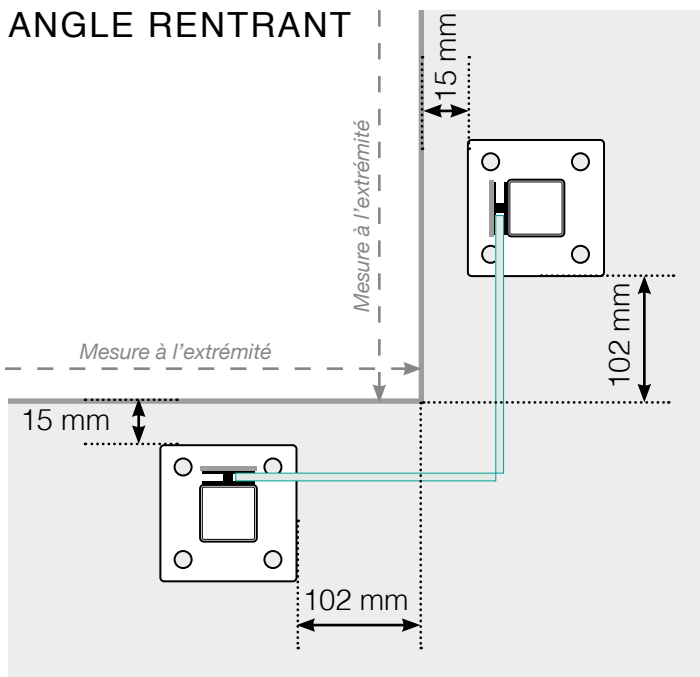

## POTEAU DE FIN

Libre

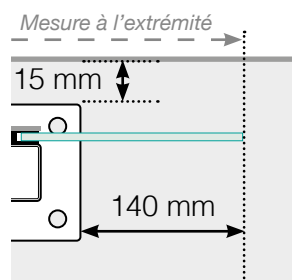

Libre Fixé au mur

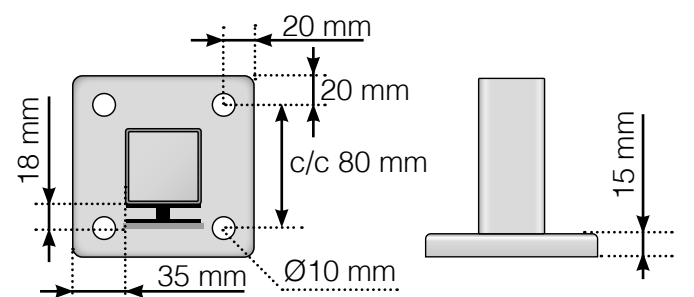
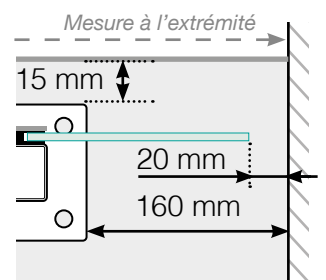

**Veillez noter que les dessins ne sont pas à l'échelle.**

© Räckesbutiken Sweden AB - [www.maisondugarde-corps.fr](http://www.maisondugarde-corps.fr)  
2018-11-01 v.1.0